

声明：由于设计印刷关系，可能与实际产品的颜色尺寸有所差异，使用时请以实物为准
Note: Due to the design and printing, the color and size may be different from the actual product. Please refer to the actual product when using.

EUROMEDA[®]
欧美嘉

智能化及自动门控解决方案

荣誉出品

广州市欧美嘉实业投资有限公司

技术支持

欧美嘉信息技术(深圳)有限公司

商务地址：广东省佛山市南海盐步东门工业区欧美嘉研发中心

<http://www.euromeda.cn>



2021年刊



智能 | 安全 | 灵动 | 服务
Smart | Safety | Sensitive | Service

4S品格

智能门⁺新零售客流量管理系统

平移门 | 平开门 | 旋转门 | 医用门 | 折叠门 | 疏散门 | 逃生门

我们，一直在努力！



BELONGS TO 所属单位

- 广州市欧美嘉实业投资有限公司
- 广东振盛五金有限公司
- 欧美嘉信息技术（深圳）有限公司
- 佛山市嘉铎五金有限公司

感谢
Thanks



对我们的大力支持
Strong support for us

PRODUCTS
CONTENTS

目录

系统
SYSTEM

09 / 智能门+
客流量管理系统

智能门
SMART

11 / 平移式智能门
千里通4S智能门 (120Kg)

15 / 平移式智能门
千里通4S智能门 (250Kg)

19 / 智能自动地弹簧
千里通4S智能地弹簧 (150Kg)

23 / 紧急疏散智能门
4S 紧急疏散智能门 (120Kg)

35 / 平移式自动门
新锐帝UM120 (通用型)

36 / 平移式自动门
UM-250 (重型)

37 / 平开式智能门
UM-100

全景门
PARTITION

31 / 新视野全景门
KT-上承重

33 / 新视野全景门
KB-下承重

通道门
ACCESS DOOR

41 / 两翼旋转门
MGR-620

45 / 三/四翼旋转门
MGR-630/640

49 / 自动折叠智能门
4S 自动折叠智能门

53 / 平开式智能广告门
4S 智能广告门

PROFESSIONAL 专业



QUALITY 品质



GUARANTEE 保障



PUBLIC PRAISE 口碑



一味模仿，窃取了别人创意，当然可以通过这条捷径快速成功。
不断廉价，抢夺了对手市场，也许能够使用这把利器获得销量。
而廉价模仿，永远无法改变世界，更无法满足用户舒适的生活品质。
所以.....

我们 **不一样**
THINGS

DIFFERENT

新零售 客流量 管理及智能门控系统

一站式大数据分析平台

这是一款通过智能硬件抓取客流量数据，利用数据挖掘、精准分析、远程操控等技术，帮助企业分析提高销量和人均贡献值等有效数据，实现企业提高门店营销、员工效率管理的协作工具，降低门店获客成本及人力成本，实现企业数字化经营管理。



BUSINESS IS MUCH MORE BETTER FROM OUR HELP
www.euromega.cn

平移式智能门

TRANSLATION TYPE INTELLIGENT DOOR

黑科技功能

一键开门 ⇌ 随时操控，多终端远程管理

Under control all the time ,remote controlling multi-device

实时数据 ⇌ 实时反馈，降低运营成本

Real-time data feedback for saving costs

即时售后 ⇌ 1对1在线售后，全国网点随时服务

On duty all time ,served all nationwide

模式切换 ⇌ 根据需要，任意切换门禁状态

Switch status as you want

客流跟踪 ⇌ 促销策略随时针对性调整

Adjust business strategy immediately

状态监控 ⇌ 门禁状态实时掌控

Real-time monitoring of access

人员管理 ⇌ 内部人员权限管理及时到位

Authority management of personnel in place in time

紧急疏散 ⇌ 一键及时保障安全

Emergency evacuation by one function

未来商店 WEEKEND SHOP

WEEKEND SHOP

千里通 4S 智能门 (120Kg)

适用场所：医院 | 商铺 | 大厦 | 商业中心 | 综合体 | 会场 | 办公室

一键开门



千里通 4S 智能门 (120Kg)



安全性
SECURITY

碰到障碍物时可立即打开

当门扇于关闭状态时，碰触行人或障碍物等状态时，门扇可自动反转，立即开门，防止夹人事件和机组损坏现象发生，提高自动门的寿命。

停电时门扇开启轻巧方便

正在进行开闭工作时，如果停电，门就会自动停止动作。并且门扇的阻力很小，可以轻松用手开门。

Controller Module

When the door is in the closed state, when touching pedestrians or obstacles, the door can automatically reverse, immediately open the door, to prevent the occurrence of clamping events and damage to the unit, to improve the life of the automatic door.

Motor Module

In the process of opening and closing, if there is a power failure, the door will stop automatically. And the resistance of the door is very small, you can open the door easily by hand.

方便性
ACCESSIBILITY

良好的模块化设计，使得施工非常简单。只需要把各种模块装上大梁内，然后链接好，通电即可运行。

Good modular design makes construction very simple. Simple put the various modules into the beam, and then connected, electrified can run.

技术参数
TECHNICAL DATA

门体形式 Door configuration	单开门 Single leaf	双开门 Double leaves
承载重量 Limited Weight	≤1x150kg	≤ 2x120kg
门扇宽度 Door leaf width	700~1300mm	600~1200mm
电源电压 Power voltage	AC 110V~220V±10%, 50~60Hz	
功率消耗 Power consumption	<70W	
开门速度 Opening speed	200~450 mm/s (可调)	
关门速度 Closing speed	200~450 mm/s (可调)	
开放时间 Hold-open time	0~9 s (可调)	
手动开合力 Manual force	<40N	<50N
传感形式 Sensor mode	适合各种模式传感器	
运行噪音 Sliding noise	≤ 55Db	
环境温度 Environment temperature	-20°C ~ 50°C	

电动机模块

采用体积小，功率大的直流无碳刷马达，配合传动效率高、噪音小的高速齿轮箱系统减速，然后驱动皮带。内部有安全装置，即使长期频繁开闭，也不会发生故障。电动传动皮带轮使用金属制造，耐用易保养。

控制器模块

接受传感器或其他信号开关的检测信号，可实现远程操控及数据传输功能。驱动马达，控制门体按照合适的轨迹运动。简便设计，不必使用变压器，内置两组辅助光线传感器接口、辅助功能接口，提高产品安全性同时，还让更多智能化功能得以实现。



平移式智能门

TRANSLATION TYPE INTELLIGENT DOOR

黑科技功能

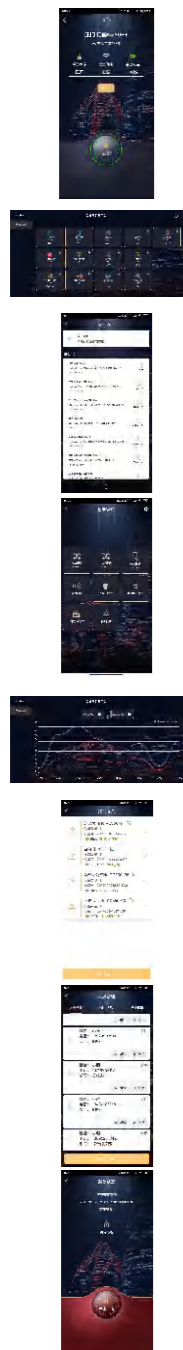

一键开门 ⇌ 随时操控，多终端远程管理
Under control all the time ,remote controlling multi-device

实时数据 ⇌ 实时反馈，降低运营成本
Real-time data feedback for saving costs

即时售后 ⇌ 1对1在线售后，全国网点随时服务
On duty all time ,served all nationwide

模式切换 ⇌ 根据需要，任意切换门禁状态
Switch status as you want

客流跟踪 ⇌ 促销策略随时针对性调整
Adjust business strategy immediately

状态监控 ⇌ 门禁状态实时掌控
Real-time monitoring of access

人员管理 ⇌ 内部人员权限管理及及时到位
Authority management of personnel in place in time

紧急疏散 ⇌ 一键及时保障安全
Emergency evacuation by one function



实时数据

千里通 4S 智能门 (250Kg)

适用场所：医院 | 商铺 | 大厦 | 商业中心 | 综合体 | 会场 | 办公室 | 工业企业



千里通 4S 智能门 (250Kg)



Door configuration: Single leaf/Double leaves
 Limited Weight: $\leq 1 \times 300\text{kg}$, $\leq 2 \times 250\text{kg}$
 Door leaf width: 1000~2800mm, 1800~3800mm
 Power voltage: AC 220V $\pm 10\%$, 50~60Hz
 Power consumption: <100W
 Opening speed: 300~550 mm/s (adjustable)
 Closing speed: 200~500 mm/s (adjustable)
 Hold-open time: 1~10 s (adjustable)
 Manual force: <100N
 Sliding noise: $\leq 55\text{Db}$
 Environment temperature: -20°C ~ 50°C

技术参数
 TECHNICAL DATA

门体形式 Door configuration	单开门 Single leaf	双开门 Double leaves
承载重量 Limited Weight	$\leq 1 \times 300\text{kg}$	$\leq 2 \times 250\text{kg}$
门扇宽度 Door leaf width	1000~2800mm	1800~3800mm
电源电压 Power voltage	AC 220V $\pm 10\%$, 50~60Hz	
功率消耗 Power consumption	<100W	
开门速度 Opening speed	300~550 mm/s (可调)	
关门速度 Closing speed	200~500 mm/s (可调)	
开放时间 Hold-open time	1~10 s (可调)	
手动开合力 Manual force	<100N	
运行噪音 Sliding noise	$\leq 55\text{Db}$	
环境温度 Environment temperature	-20°C ~ 50°C	

功能简介
 FUNCTION INTRODUCTION

新型重型门，采用现代化设计，应用全球信赖的大功率无刷电机及全新的机械组件，吊件（架）采用进口高强度尼龙，机组承重达到2x250Kg。全新设计的机组已经通过多项测试。适用于各种大型通道、工业车间等场所，运行平稳，安装简便，易于维护。



The new heavy-duty door adopts modern design, uses the high-power brushless motor and new mechanical components trusted by the world. The hanger (frame) adopts imported high-strength nylon, and the unit bearing capacity reaches 2x250kg. The newly designed unit has passed many tests. It is suitable for various large channels, industrial workshops and other places, with stable operation, simple installation and easy maintenance.

智能电动地弹簧

SWING DOOR
EMBEDDED

黑科技功能

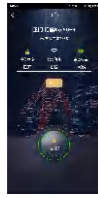

一键开门 ⇌ 随时操控，多终端远程管理
Under control all the time ,remote controlling multi-device



实时数据 ⇌ 实时反馈，降低运营成本
Real-time data feedback for saving costs



即时售后 ⇌ 1对1在线售后，全国网点随时服务
On duty all time ,served all nationwide



模式切换 ⇌ 根据需要，任意切换门禁状态
Switch status as you want



客流跟踪 ⇌ 促销策略随时针对性调整
Adjust business strategy immediately



状态监控 ⇌ 门禁状态实时掌控
Real-time monitoring of access

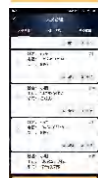

人员管理 ⇌ 内部人员权限管理及及时到位
Authority management of personnel in place in time

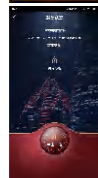

紧急疏散 ⇌ 一键及时保障安全
Emergency evacuation by one function



千里通 4S 智能地弹簧 (150Kg)

适用场所：医院 | 商铺 | 大厦 | 商业中心 | 综合体 | 会场 | 办公室

模式切换

技术参数

TECHNICAL DATA

- 最大门重: 150kg
- 最大门宽: 1200mm
- 最大扭矩: 165Nm
- 机组重量: 5.5kg
- 安装方式: 地面埋置
- 运行噪音: < 60dB
- 电锁输出: DC12V 常开/常闭触点
- 开闭时间: 6-12S
- 开启范围: 86°- 95°
- 电源电压: AC220V±10%, 50/60Hz
- 额定功率: 55W
- 待机功率: < 2W
- 工作温度: -20 ~ +50°C
- 防护等级: Ip68
- 机组尺寸: 330 X 116 X100 (mm)
- 控制箱尺寸: 215 X 205 X 60 (mm)



产品特点

PRODUCT FEATURES

- 控制器全中文调试界面，操作简单方便，配有电锁、后备电池等多种功能端口。
- 机外壳为BMC注塑成型；直流电机全部密封超级防水，绝缘防火，耐腐蚀性强。
- 最大承重150KG，可选欧美嘉机组90度开门或欧美嘉机组180度开门（自动感应行人的通过方向，而随着行人的行走方向开门）。
- 耐寒、耐高温，可在-20°C-55°C环境下工作。
- 体积小巧，防水好，载重大，施工简易等，可同时应用于室内和室外。
- 双向180度开启，可设置单向开启。

Features

- The controller has display debugging interface, which is easy to operate and is equipped with various function ports such as electric lock and backup battery.
- The casing of the machine is injection molded by BMC; all DC motors are sealed to be super waterproof, fireproof and corrosion resistant.
- The Max. load is 150KG, the optional DSW-3 unit can be opened 90 degrees or the DSW-3A unit can open the door 180 degrees (automatically sensing the passing direction of pedestrians, and opening the door with the pedestrian walking direction).
- It is cold-resistant and high-temperature resistant and can work in -20°C-55°C environment.
- Small size, waterproof, heavy load, easy construction, etc., can be used indoors and outdoors.
- Double Side 180 degree opening, one-side opening can be set.

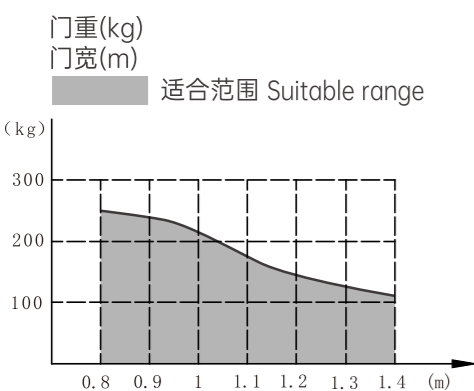

Technical data

- Max. door weight: 150kg
- Max. door width: 1200mm
- Max. torque: 165Nm
- Unit weight: 5.5kg
- Installation method: ground embedding
- Running noise: <60dB
- Electric lock output: DC12V NO / NC
- Opening /Closing time: 6-12S
- Opening range: 86°- 95°
- Power supply : AC220V±10% , 50/60Hz
- Rated power: 55W
- Standby power: <2W
- Working temperature: -20 ~ +50°C
- Protection level: IP68
- Unit size: 330 X116 X100 (mm)
- Control box size: 215X205X60 (mm)

安装示意图

Installation diagram

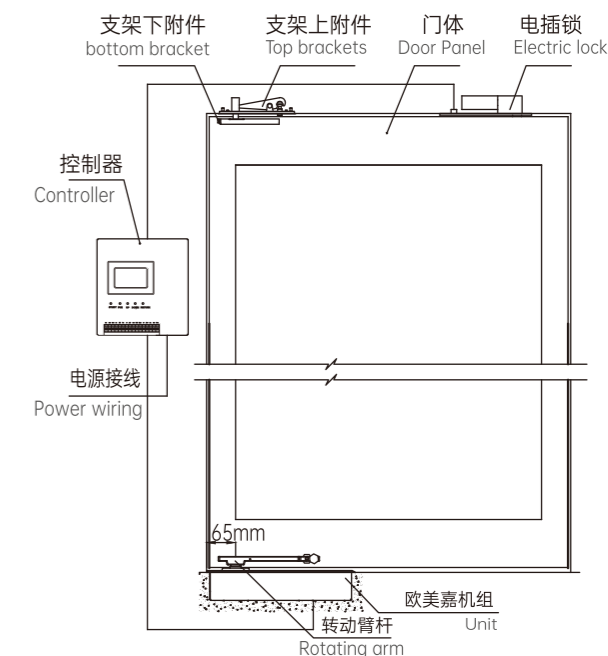

配件 ACCESSORIES

欧美嘉自动地弹簧
Unit



欧美嘉控制器
Controller



欧美嘉电源线
Power Cable



欧美嘉遥控器
Remote Control



欧美嘉转动臂杆
Rotating arm



欧美嘉扳手
Spanner



欧美嘉支架上附件
Top brackets



欧美嘉支架下附件
bottom bracket



紧急疏散智能门

EMERGENCY EVACUATION INTELLIGENT DOOR

黑科技功能

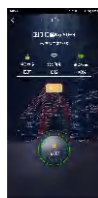

一键开门 ⇌ 随时操控，多终端远程管理
Under control all the time ,remote controlling multi-device



实时数据 ⇌ 实时反馈，降低运营成本
Real-time data feedback for saving costs



即时售后 ⇌ 1对1在线售后，全国网点随时服务
On duty all time ,served all nationwide



模式切换 ⇌ 根据需要，任意切换门禁状态
Switch status as you want



客流跟踪 ⇌ 促销策略随时针对性调整
Adjust business strategy immediately



状态监控 ⇌ 门禁状态实时掌控
Real-time monitoring of access

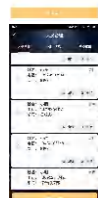

人员管理 ⇌ 内部人员权限管理及时到位
Authority management of personnel in place in time



紧急疏散 ⇌ 一键及时保障安全
Emergency evacuation by one function



4S 紧急疏散智能门 (120Kg)

适用场所：购物中心 | 医院 | 酒店 | 汽车展厅 | 机场 | 火车站

适用于有安全要求，需比较大空间的出入口通道

Applicable to the safety requirements,the entrance channel needs more space for export.Such as shopping malls,hospitals,car showrooms,airports,railway stations and other places.

紧急疏散



关闭状态
Closed state

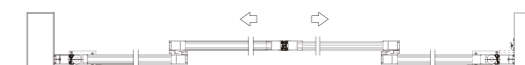

平移使用状态
Translation state



紧急逃生状态
Emergency evacuation



Bigger evacuation routes are just for more safety
更大疏散通道 只为更安全

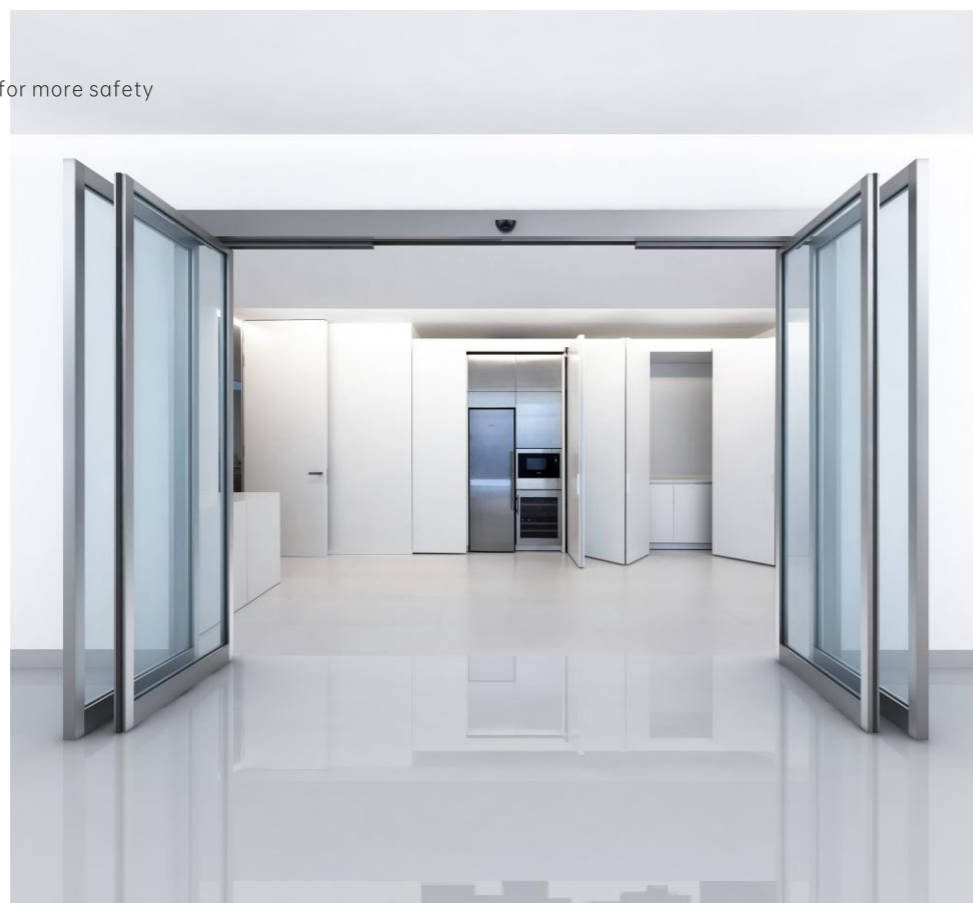

技术参数 TECHNICAL DATA

门体形式 Door configuration	单开型 Single leaf	双开型 Double leaves
净开宽度 Clean opening width	DW=800~1200mm	DW=800~2500mm
承载重量 Limited Weight	≤ 1x150Kg	≤ 2x120Kg
通行高度 Clean pass height	2500mm	
开门速度 Opening speed	200~500 mm/s (可调)	
关门速度 Closing speed	300~500 mm/s (可调)	
开放时间 Hold-open time	2~20 s (可调)	
手动开合力 Manual force	<100N	
电源电压 Power voltage	220V±10%	
功率消耗 Power consumption	<100W	

功能简介 FUNCTION INTRODUCTION

该系统的主要功能是在遇到特殊情况时（如火灾），平滑自动门门扇可手动旋转至90度打开，以提供更大的开口供行人或货物通过。作为紧急逃离疏散通道时，系统具有门扇检测功能，信号会传输到微电脑控制器，确保自动门的使用安全。微电脑控制器功能接口全面，含五项功能开关、后备电源、急停开关、消防联动等接口，拥有逃生功能，门扇可以即刻完全敞开，100%满足消防要求。门体坚硬、牢固、配件精密可靠，可以承受门扇反复旋转打开，并能够复位，保证自动门的正常运行。

The main function of the system is that in case of special circumstances (such as fire), the smooth automatic door leaf can be manually rotated to 90 degrees to open, so as to provide a larger opening for pedestrians or goods to pass through. As an emergency escape evacuation channel, the system has a door detection function, the signal will be transmitted to the microcomputer controller, to ensure the use of the automatic door safety. The function interface of microcomputer controller is comprehensive, including five function switches, backup power supply, emergency stop switch, fire linkage and other interfaces, with escape function, the door leaf can be fully opened immediately, 100% meeting the fire protection requirements. The door body is hard, firm, the fittings are precise and reliable, can bear the door to turn repeatedly to open, and can reset, to ensure the normal operation of the automatic door.

不是没有困难，我们也常迷茫，也曾彷徨。
只是我们从不怀疑，坚守品质的原则虽让我们很痛苦，
放弃原则的后果会让我们更痛苦！
因此.....

只有 **A** 品质
ONLY
A LEVEL



VISION

视野 开拓格局

Develop the grading

新视野全景门

Series

NEW VISION Panoramic Glass Door



静音滑轮



简约拉手



夹胶玻璃

(可选配)



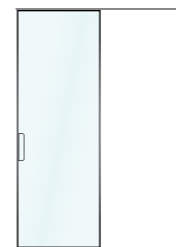

KT001

单推拉全景门



定制范围: 宽Lx高H
(700-1200)x(2000-2600)mm
玻璃厚度: 10mm/4+4mm夹胶玻璃
边框材质: 铝材
边框颜色: 亚黑/枪灰

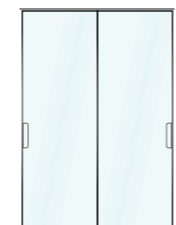

KT002

双推拉全景门



定制范围: 宽Lx高H
(1600-1200)x(2000-2600)mm
玻璃厚度: 10mm/4+4mm夹胶玻璃
边框材质: 铝材
边框颜色: 亚黑/枪灰

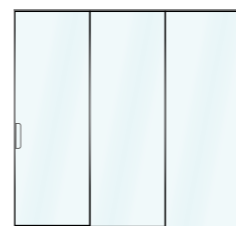

KT012

一固两移联动全景门



定制范围: 宽Lx侧Wx高H
(2000-2600)x(2000-2600)mm
玻璃厚度: 10mm/4+4mm夹胶玻璃
边框材质: 铝材
边框颜色: 亚黑/枪灰

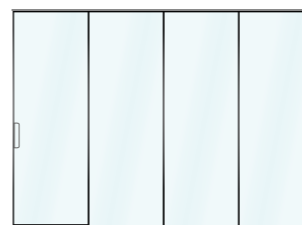

KT013

一固三移联动全景门

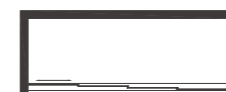

定制范围: 宽Lx高H
(2400-3000)x(2000-2600)mm
玻璃厚度: 10mm/4+4mm夹胶玻璃
边框材质: 铝材
边框颜色: 亚黑/枪灰

TECHNICAL POINTS

技术特点

- | | |
|---|--|
| <ul style="list-style-type: none"> 1 优质铝材。 2 全系列采用欧派克缓冲滑轮，顺滑静音，尽显写意质感。 3 全系列选配多种4+4mm夹胶玻璃，更安全。 4 无下轨道、无侧边框设计。 5 全包框设计，北欧风和工业风搭配，双倍舒适度。 6 与框架一体设计而成的拉手，简洁干练。 | <ul style="list-style-type: none"> 1 High-class aluminium material. 2 Using whole series top class sliding rollers, silently and smoothly. 3 Using transparent 4+4 poly glass, durable and safe. 4 Using hanger track and top frame only. 5 Door full frame design comes from Nordic and Industrial style. 6 Handle linking with the frame, simple and creative. |
|---|--|



KB002

双推拉全景门



定制范围：宽Lx高H
(1600-2400)x(2000-2600)mm
玻璃厚度：10mm/4+4mm夹胶玻璃
边框材质：铝材
边框颜色：亚黑/枪灰

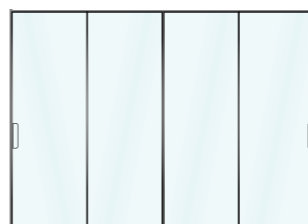

KB022

二固定二联动全景门



定制范围：宽Lx高H
(2400-4000)x(2000-2600)mm
玻璃厚度：10mm/4+4mm夹胶玻璃
边框材质：铝材
边框颜色：亚黑/枪灰

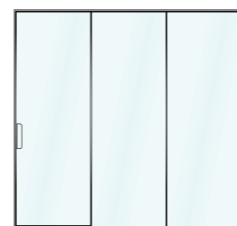

KB012

一固定二联动全景门



定制范围：宽Lx侧Wx高H
(2000-3000)x(2000-2600)mm
玻璃厚度：10mm/4+4mm夹胶玻璃
边框材质：铝材
边框颜色：亚黑/枪灰

TECHNICAL POINTS

技术特点

- | | |
|---|---|
| <ul style="list-style-type: none"> 1 优质铝材。 2 全系列采用欧派克缓冲滑轮，顺滑静音，尽显写意质感。 3 全系列选配多种4+4mm夹胶玻璃，更安全。 4 下承重轨道、全边框设计，整体性更强。 5 全包框设计，北欧风和工业风搭配，双倍舒适度。 6 与框架一体设计而成的拉手，简洁干练。 | <ul style="list-style-type: none"> 1 High-class aluminium material. 2 Using whole series top class sliding rollers, silently and smoothly. 3 Using transparent 4+4 poly glass, durable and safe. 4 Unitary style by using full-frame design with the bottom track. 5 Door full frame design comes from Nordic and Industrial style. 6 Handle linking with the frame, simple and creative. |
|---|---|

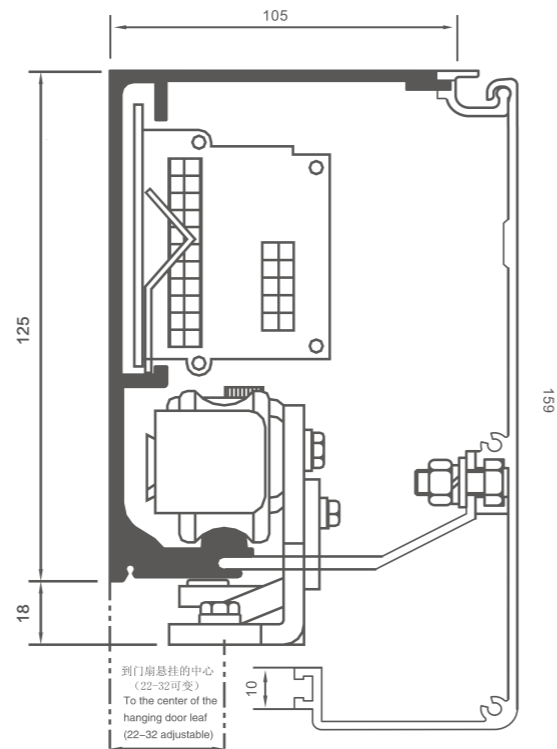
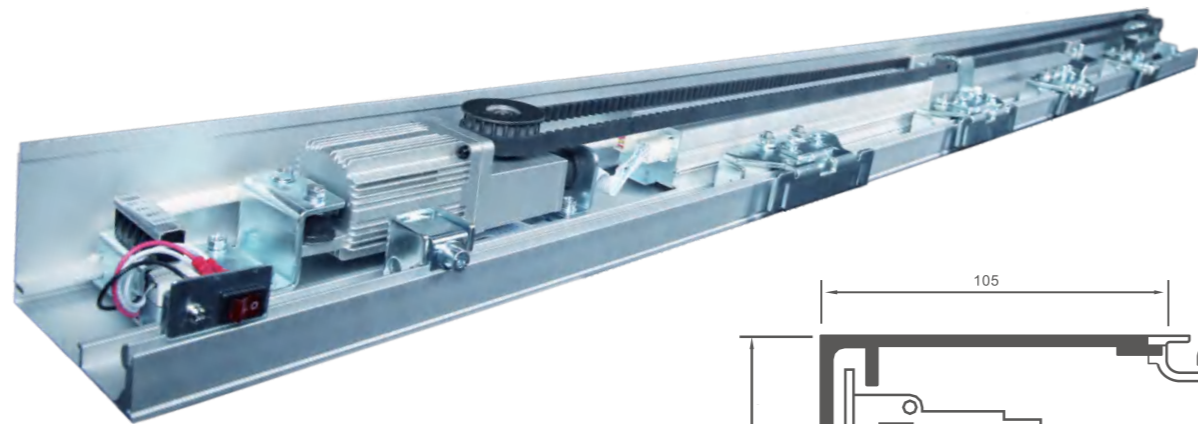

控制器模块

接受传感器或其他信号开关的检测信号，可实现远程操控及数据传输功能。驱动马达，控制门体按照合适的轨迹运动。简便设计，不必使用变压器，内置两组辅助光线传感器接口、辅助功能接口，提高产品安全性同时，还让更多智能化功能得以实现。

电动机模块

采用体积小，功率大的直流无刷马达，配合传动效率高、噪音小的高速齿轮箱系统减速，然后驱动皮带。内部有安全装置，即使长期频繁开闭，也不会发生故障。电动传动皮带轮使用金属制造，耐用易保养。

技术参数

TECHNICAL DATA

门体形式 Door configuration	单开门 Single leaf	双开门 Double leaves
承载重量 Limited Weight	≤1x150kg	≤ 2x120kg
门扇宽度 Door leaf width	700~1300mm	600~1200mm
电源电压 Power voltage	AC 110V~220V±10%, 50~60Hz	
功率消耗 Power consumption	<70W	
开门速度 Opening speed	200~450 mm/s (可调)	
关门速度 Closing speed	200~450 mm/s (可调)	
开放时间 Hold-open time	0~9 s (可调)	
手动开合力 Manual force	<40N	<50N
传感形式 Sensor mode	适合各种模式传感器	
运行噪音 Sliding noise	≤ 55Db	
环境温度 Environment temperature	-20°C ~ 50°C	

安全性

SECURITY

碰到障碍物时可立即打开

当门扇于关闭状态时，碰触行人或障碍物等状态时，门扇可自动反转，立即开门，防止夹人事件和机组损坏现象发生，提高自动门的寿命。

停电时门扇开启轻巧方便

正在进行开闭工作时，如果停电，门就会自动停止动作。并且门扇的阻力很小，可以轻松用手开门。

Controller Module

When the door is in the closed state, when touching pedestrians or obstacles, the door can automatically reverse, immediately open the door, to prevent the occurrence of clamping events and damage to the unit, to improve the life of the automatic door.

Motor Module

In the process of opening and closing, if there is a power failure, the door will stop automatically. And the resistance of the door is very small, you can open the door easily by hand.

方便性

ACCESSIBILITY

良好的模块化设计，使得施工非常简单。只需要把各种模块装上大梁内，然后链接好，通电即可运行。

Good modular design makes construction very simple. Simple put the various modules into the beam, and then connected, electrified can run.

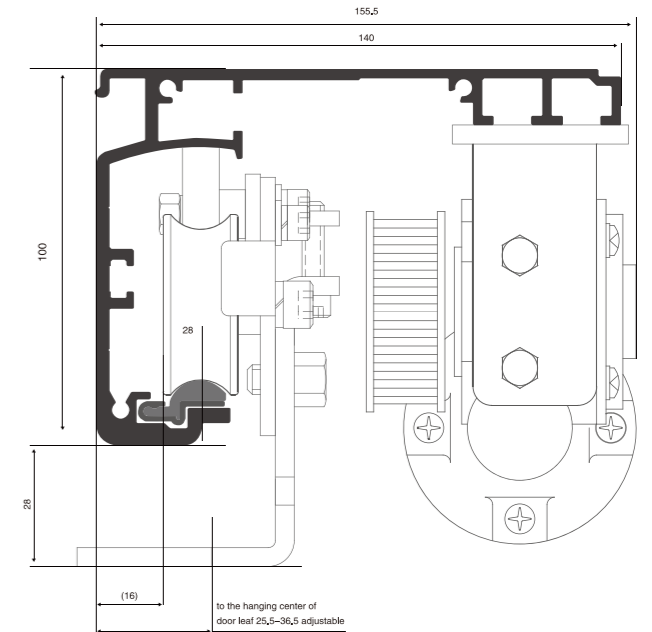
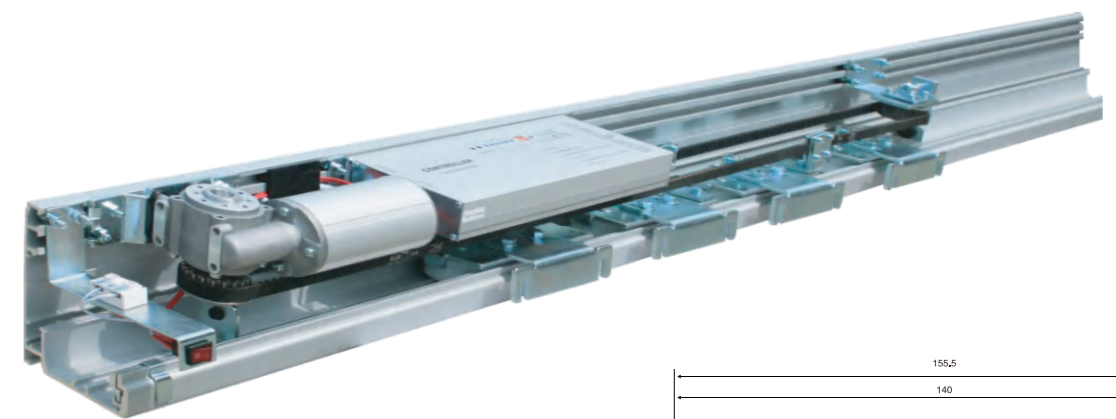

功能简介

FUNCTION INTRODUCTION

新型重型门，采用现代化设计，应用全球信赖的大功率无刷电机及全新的机械组件，吊件（架）采用进口高强度尼龙，机组承重达到2x250Kg。全新设计的机组已经通过多项测试。适用于各种大型通道、工业车间等场所，运行平稳，安装简便，易于维护。

技术参数

TECHNICAL DATA

门体形式 Door configuration	单开门 Single leaf	双开门 Double leaves
承载重量 Limited Weight	≤1x300kg	≤ 2x250kg
门扇宽度 Door leaf width	1000~2800mm	1800~3800mm
电源电压 Power voltage	AC 220V±10%, 50~60Hz	
功率消耗 Power consumption	<100W	
开门速度 Opening speed	300~550 mm/s (可调)	
关门速度 Closing speed	200~500 mm/s (可调)	
开放时间 Hold-open time	1~10 s (可调)	
手动开合力 Manual force	<100N	
运行噪音 Sliding noise	≤ 55Db	
环境温度 Environment temperature	-20°C ~ 50°C	

The new heavy-duty door adopts modern design, uses the high-power brushless motor and new mechanical components trusted by the world. The hanger (frame) adopts imported high-strength nylon, and the unit bearing capacity reaches 2x250kg. The newly designed unit has passed many tests. It is suitable for various large channels, industrial workshops and other places, with stable operation, simple installation and easy maintenance.

Door configuration: Single leaf/Double leaves

Limited Weight: ≤ 1x300kg, ≤ 2x250kg

Door leaf width: 1000~2800mm, 1800~3800mm

Power voltage: AC 220V±10%, 50~60Hz

Power consumption: <100W

Opening speed: 300~550 mm/s (adjustable)

Closing speed: 200~500 mm/s (adjustable)

Hold-open time: 1~10 s (adjustable)

Manual force: <100N

Sliding noise: ≤ 55Db

Environment temperature: -20°C ~ 50°C

平开式智能门

FLAT OPEN TYPE
INTELLIGENT DOOR



超静音运作



微波探头



智能防夹

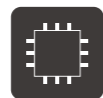

智能控制



消防功能



UM-100

适用场所：医院 | 商铺 | 大厦 | 商业中心 | 综合体 | 会场



Mix and match just to be more practical
随意组合 只为更实用



UM-100

技术参数

TECHNICAL DATA

门体形式 Door configuration	单开门 Single leaf
承载重量 Limited Weight	≤1x100kg
门扇宽度 Door leaf width	≤ 1200mm
电源电压 Power voltage	AC 220V±10%, 50~60Hz
功率消耗 Power consumption	<50W
开门速度 Opening speed	250~450 mm/s (可调)
关门速度 Closing speed	250~400 mm/s (可调)
开放时间 Hold-open time	1~30 s (可调)
手动开合力 Manual force	<30N
运行噪音 Sliding noise	≤ 55Db
环境温度 Environment temperature	-20°C ~ 50°C

功能简介

FUNCTION INTRODUCTION

驱动装置运行噪音低、性能可靠、使用安全，给生活和工作环境提供更多的便利。

运行中遇到有障碍物和人员，门就会向反方向打开。

机械部分设计创新，安装人员安装快捷有效。

提供传感器、门禁、安全光线保护等接口，配置电锁、电源输出接口。

可以选择无线遥控器开门方式。必要时可以配置紧急电源，满足安防要求。

可以实现门与门之间的互锁功能。

Driving devices orks with low noise, reliable performance, safety and brings living and working environment more convenience.

In case of meeting obstacles or personnel during operation, the door will be opened to reverse direction.







Innovation in mechanical design offers and effective installation.

With sensors, access control, safety beam protection interfaces, configurate electric lock, power output interface.

It can realize the interlock function between door and door.

两翼旋转门

TWO WING
AUTO-REVOLVING DOOR

-  智能防夹
-  无刷电机
-  智能控制
-  超静音运作
-  牢固可靠
-  安全稳定



MGR-620

适用场所：酒店 | 商业中心 | 综合体 | 办公大楼

功能简介

FUNCTION INTRODUCTION

检测旋转功能、紧急停止功能、防风防尘功能、中控消防功能、中央门开启功能。可编程控制功能、故障自检功能、夜间锁闭功能、门禁控制功能、变频、调速功能、安全防碰、防夹功能、UPS应急供电功能（选配）、停门位切换功能、慢速等待功能、防夹反转功能、定门位功能。

Detect the rotation function, emergency stop function, wind and dust prevention function, central control fire fighting function and central door opening function. Programmable logic control function, fault self inspection function, night locking function, access control function, frequency conversion, speed regulation function, safety anti-collision, anti pinch function, UPS emergency power supply function (optional), stop position switching function, slow waiting function, anti pinch reverse function, door position setting function.

技术参数

TECHNICAL DATA

∅	3600	4200	4800
A	2200-3200		
B	2300-3500		
C	1670	1970	2270
D	3600	4200	4800
E	3810	4410	5010

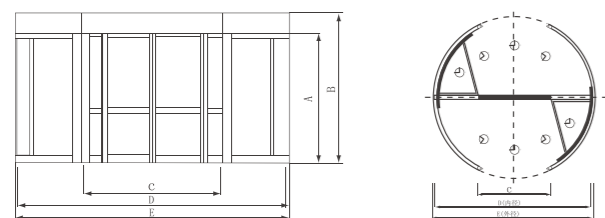

工作电压：AC单项电流220V 50-60Hz

功率：驱动单位：0.2-0.6KW+照明500W

全智能电脑控制单元

变频器：多级控制、变频调速

传感器：雷达（红外线）动作感应器，橡胶及红外防撞防夹传感器

保险装置：16A或2x10A

Supply power: AC 220V 50-60Hz

Power consumption: motor 200-600W, light 500W

Intelligent computer control

Multilevel control, frequency control of motor speed

Sensor: radar(infra-red) motion sensors

Safety device: 16A or 2x10A



传感器配置

SENSORS

- 旋转门启动传感器（安装在帽头：内藏型）{红外线}—4台
- 防夹传感器（安装在内圈：内藏型）{红外线放射式}—2台
- 防夹传感器（安装在帽头：内藏型）{红外线放射式}—2台
- 防夹传感器{挤压式}—4套
- 防夹脚传感器{红外线放射式}—2台
- 防撞撞传感器{红外线放射式}—4组
- 缓冲胶条—2套
- 慢速按钮—2套

- Door operation sensors(concealing){infra-red}—4pcs
- Anti-pinch sensors(concealing){infra-red reflection}—2pcs
- Anti-pinch sensors(concealing){infra-red reflection}—2pcs
- Anti-pinch sensors{extrusion mode}—4sets
- Anti-pinch foot sensors{infra-red reflection}—2pcs
- Anti-collision sensors{infra-red reflection}—4pcs
- Buffer rubber—2sets
- Slow speed button—2sets

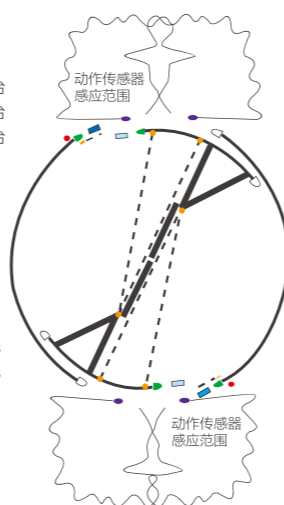

可选项目

OPTIONAL

- 1 表面处理：型材表面不锈钢饰面（镜面、发纹、钛金），型材表面氟碳喷涂、烤漆等。
- 2 消防中央系统
- 3 门禁管理系统

- 1 Surface treatment: profile surface stainless steel finish (mirror, hair, titanium), profile surface fluorocarbon spraying, baking paint.
- 2 Fire central system.
- 3 Access control system.

STANDARD CONFIGURATION

标准配置

1 门体

特殊铝合金型材门体框。

2 玻璃

门扇及箱体为6/8mm透明钢化玻璃，弧形墙为10mm钢化玻璃（5+5mm弧形安全夹胶玻璃）。

3 驱动器

2台AC100-240V, 50-60Hz, 0.2-0.6KW范围。

4 抗扰器

防止电磁波干扰功能。

5 中控电脑

可编程逻辑控制系统。

6 转速控制

变频式调速系统，启动、运转、停止状态平衡。

7 UPS控制箱

停电故障时，UPS会启动平开感应门。

8 传感器

红外线动作感应器，出入口垂直橡胶防夹传感器，门扉下部防撞传感器，红外线直测式防夹传感器。

9 紧急停止按钮

位于出入口右侧立柱，用于紧急状态。

10 残障按钮

置于入口右侧立柱，适用残障人士慢速通过。

11 电磁锁设置可自动锁定转门。

可自动锁定转门。

12 状态及故障显示器

正确显示旋转门运行或障碍时的信息代码。

13 消防中控装置

中央感应门与楼宇火警信号连接，在紧急状态下迅速开启，使之成为疏散通道。

14 停门位功能

设冬季停门位、夏季停门位、中央自动门停门位、慢速等待状态。

15 防夹反转功能

1 Door Body

Special aluminum door profile.

2 Glass

Door leaf and exhibition box are 6/8mm transparent tempered glasses, curved wall is 10mm tempered glass(5+5mm arc safety laminated glass).

3 Drive device

Tow sets AC100-240V,50-60Hz,0.2-0.6KW.

4 Anti-interference

Function of preventing electromagnetic interference.

5 Central control computer

Programmable logic control system,automatic and manual optional.

6 Revolving speed control

Variable frequency speed regulation system, start, run, stop state balance.

7 UPS control box

In case of power failure, UPS will start the flat open induction door.

8 Sensor

Infra-red (radar) motion sensor, vertical rubber clamp-proof sensor at the entrance and exit, anti-collision sensor at the lower part of the door, infrared direct measurement type clamp-proof sensor.

9 Emergency stop button

Located on the right column of the entrance and exit for emergency.

10 Button for disabled

Placed on the right column of the entrance for people with disabilities to pass slowly.

11 Electromagnetic lock setting

It can automatically lock the door.

12 Status and fault display

Correctly display the information code when the revolving door is running or obstructed

13 Central fire protection control device

The central induction door is connected with the building fire alarm, which can be opened quickly in an emergency to become an evacuation channel.

14 Door leaf stop positions setting(optional)

Winter stop position,summer stop position,stop position of middle automatic sliding door,hold-open position,stop position of slow-down waiting,etc.

15 Reverse function of anti-pinching.

三翼 / 四翼旋转门

THREE / FOUR WING
AUTO-REVOLVING DOOR



智能防夹



无刷电机

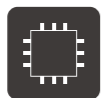

智能控制



超静音运作



牢固可靠



安全稳定

MGR-630 / 640

适用场所：酒店 | 商业中心 | 综合体 | 办公大楼

功能简介

FUNCTION INTRODUCTION

感应旋转功能、保温功能、紧急停止功能、残障人慢走功能、安全防火功能、马达锁功能、停门位功能、可调速功能、手/自动转换功能。

Induction rotation function, room temperature protection function, emergency stop function, slow walking function of the disabled, safety fire protection function, Motor lock function, door stop position function, adjustable speed function, manual / automatic conversion function.

技术参数

TECHNICAL DATA

Ø	2000	2200	2400	2600	2800	3000	3200	3400	3600
A	2200-2600								
B	2500-2900								
C	900	1000	1100	1200	1300	1400	1500	1600	1700
D	2000	2200	2400	2600	2800	3000	3200	3400	3600
E	2110	2310	2510	2710	2910	3110	3310	3510	3710

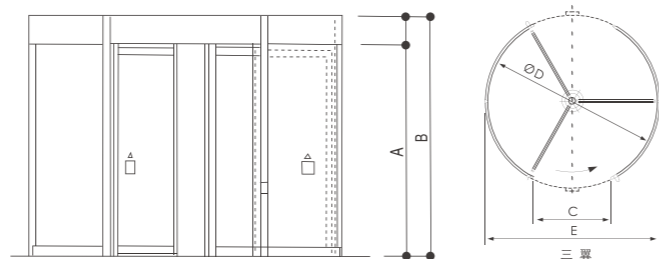

电源: AC220V±10%, 50-60Hz
功率: 0.20-0.35KW, 照明200-400W
全智能电脑控制单元
多级控制、变频调速驱动器

Supply power: AC 220V±10%, 50-60Hz
Power consumption: motor 200-350W, light 200-400W
Intelligent computer control
Multilevel control, frequency control of motor speed

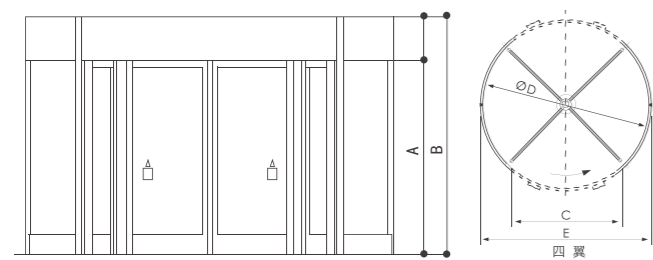

STANDARD CONFIGURATION

标准配置

1 玻璃

门扇及箱体为6/8mm透明钢化玻璃, 弧形墙为10mm钢化玻璃 (5+5mm弧形安全夹胶玻璃)。

2 驱动器

220V, 50-60Hz, 0.25-0.35KW

3 中控电脑

PLC可编程逻辑控制系统。

4 旋转程序

采用变频调速技术, 门扇启动、旋转、停止的运作平稳、安全。

5 感应装置

红外线动作感应器。

6 防夹传感器装置

出入口右侧立柱上安装防撞传感器。

7 门扇防撞

门扇下部安装橡胶防撞传感器。

8 紧急停止按钮

位于出入口右侧立柱, 用于紧急状态。

9 残障按钮

适用残障人士慢速通过。

10 马达锁

用于非适用状态。

11 镭射天花灯

6-9盏照明灯。

12 组合操作盘

功能式组合操作盘便于功能操作设定。

1 Glass

Door leaf and exhibition box are 6/8mm transparent tempered glasses, curved wall is 10mm tempered glass (5+5mm arc safety laminated glass).

2 Drive device

20V, 50-60Hz, 0.25-0.35KW

3 Central control computer

PLC programmable logic control system.

4 Revealing pattern

The use of frequency control technology, door start, rotation, stop the smooth and safe operation.

5 Sensor

Infra-red motion sensors.

6 Prevent pinching sensor

Located at the upright column at entrance right.

7 Door leaf anti-collision

Installed a sensor in the rubber strip at the bottom of the leaf(optional).

8 Emergency stop button

Located on the right column of the entrance and exit for emergency.

9 Button for disabled

Use for disabled people pass slowly.

10 Motor lock

Used when door is out of service.

11 Laser lanterns

6-9 pieces laser ceiling lamp.

12 Combination operation panel

Functional combination operation disk is convenient for setting functional operation.

自动折叠智能门

AUTOMATIC FOLDING DOOR
INTELLIGENT DOOR



牢固可靠



智能防夹



无刷电机

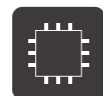

微电脑控制器



4S 自动折叠智能门

适用场所：高铁站 | 超市 | 医院 | 公寓 | 展示厅 | 办公区域 | 机场 | 家装



产品特点 PRODUCT FEATURES

- 双机组系统驱动，铝合金门体+钢化玻璃，整体构架，无缝连接。
- 开启时门体折叠，有效地节约了占用空间。
- 顺畅的门体自动开闭，可以提供舒适的通行空间，接近于平滑门效果。
- 新一代欧美嘉折叠门，安全防夹、保温、隔音、防火阻燃，更有遇阻反弹功能。
- 适用高铁站、超市、医院、公寓、展示厅、办公区域、机场、家装。

- Double unit system drive, aluminum alloy door + tempered glass, integral structure, seamless connection.
- When the door is opened, the door body is folded, which effectively saves space.
- The smooth door body automatically opens and closes, providing a comfortable passage space and close to the smooth door effect.
- A new generation of Euromega folding doors, safety anti-pinch, insulation, sound insulation, fire retardant, and more resistance to rebound.
- Applicable to high-speed railway stations, supermarkets, hospitals, apartments, exhibition halls, office areas, airports, home decoration.

技术参数 TECHNICAL DATA

门体形式 Door configuration	单开门 Single leaf	双开门 Double leaves
门扇高度 Door leaf height	最大2400mm	
门扇宽度 Door leaf width	≤ 560mm	
门洞宽度 Door width	W≤1200mm / W≤2400mm	
电源电压 Power voltage	AC 220V, 50~60Hz	
电机功率 Motor Power	65W 24V (1只) / 65W 24V (2只)	
开放时间 Hold-open time	1~30 s (可调)	
环境温度 Environment temperature	-20°C ~ 50°C	

技术图纸 TECHNICAL DRAWINGS

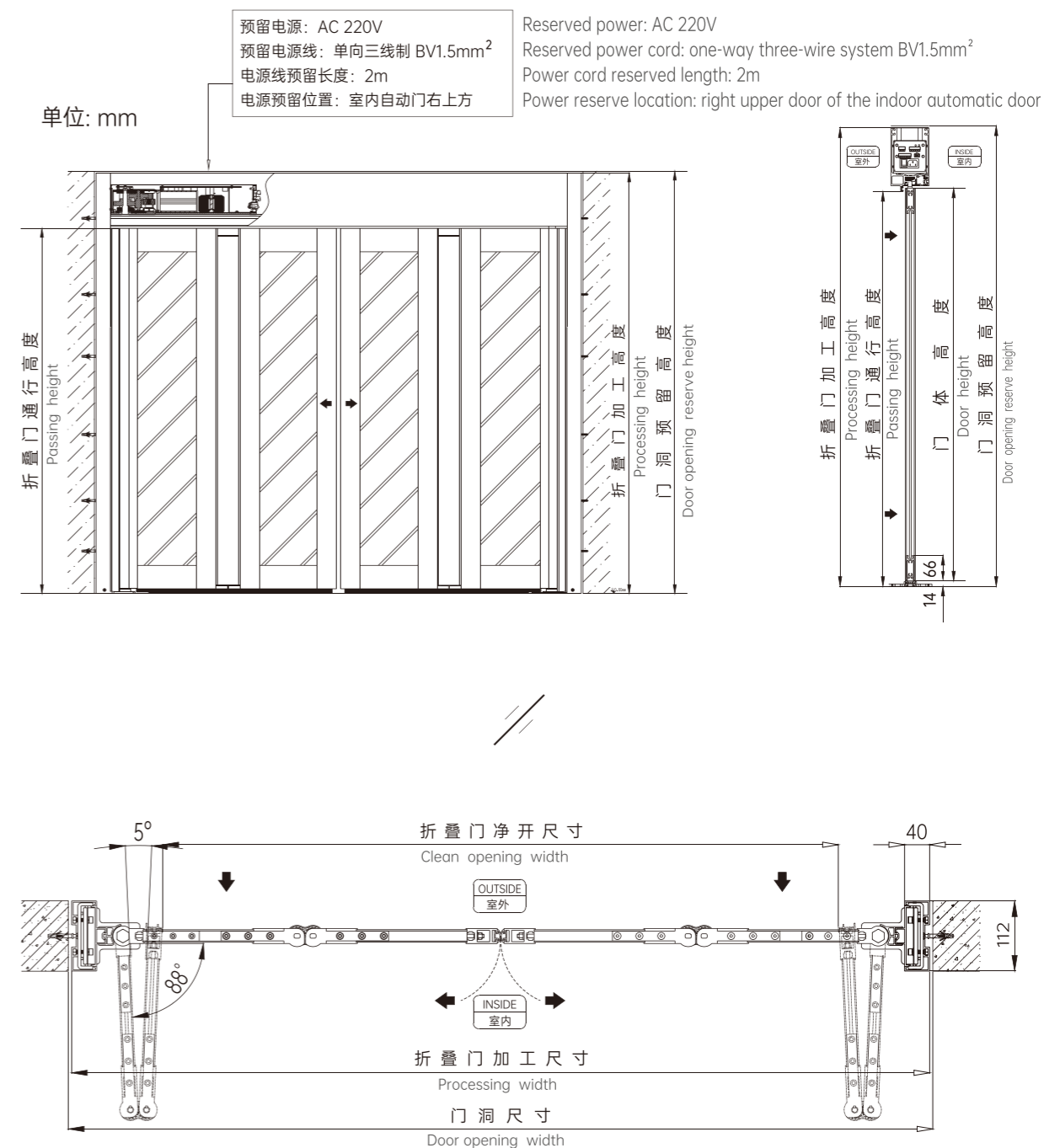

平开式智能广告门

FLAT OPEN TYPE
INTELLIGENT ADVERTISING DOOR



智能防夹



缓冲关门



耐腐蚀性强

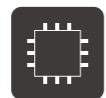

微电脑控制器

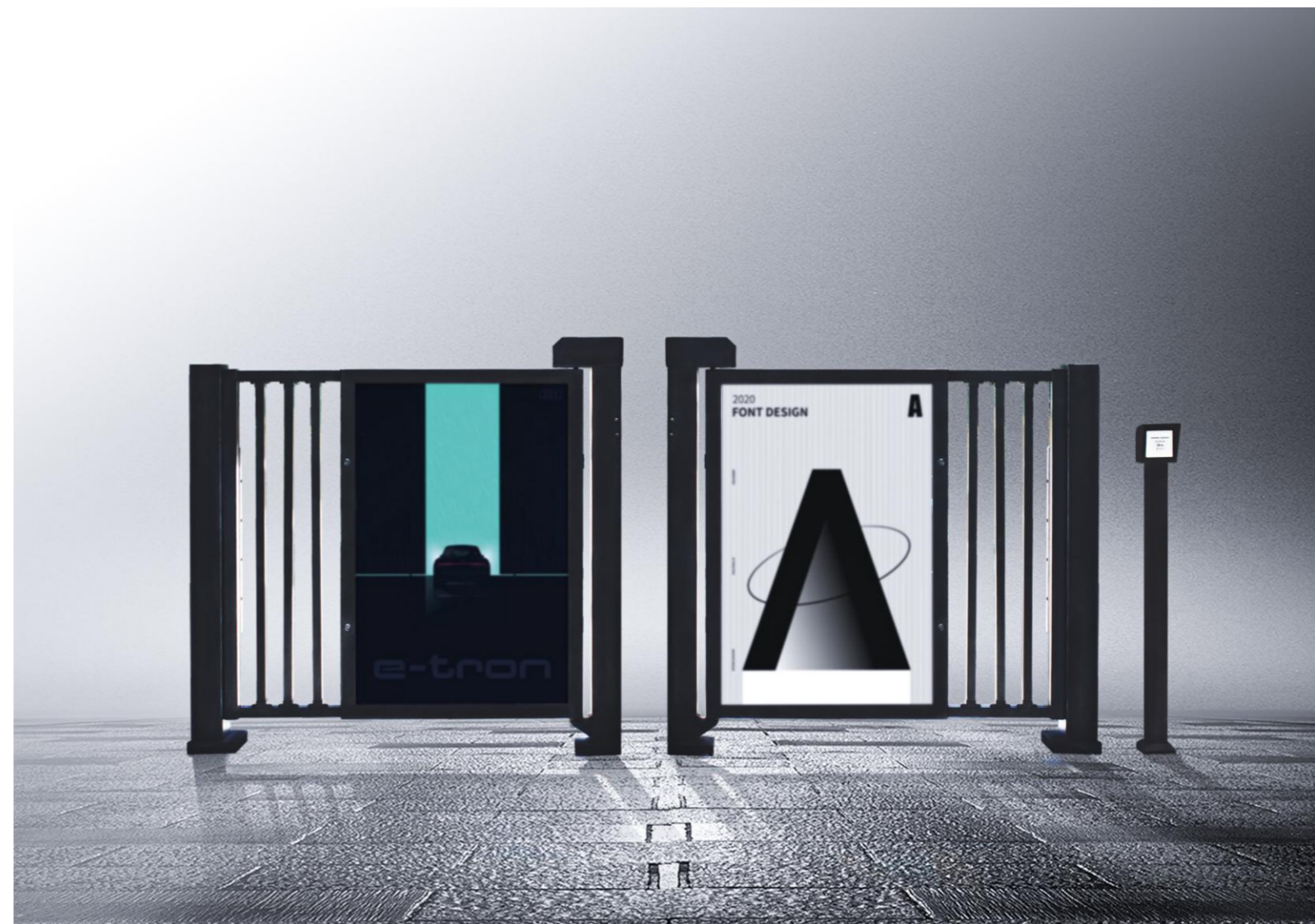

4S 智能广告门

适用场所：机场 | 火车站 | 酒店会所 | 购物中心 | 企业单位 | 居民小区 | 旅游景点 | 海关安检



技术参数

TECHNICAL DATA

- 最大门重: 110KG
- 最大门宽: 1.8m
- 工作电源: DC24V
- 电机功率: 90W
- 开门时间: 3-7S / 90°
- 关门时间: 3-7S / 90°
- 开门保持时间: 0-20S
- 最大开门角度: 95°
- 防护等级: Ip54
- 使用温度: -20 ~ +55°C

Technical data

- Max. door weight: 110KG
- Max. door width: 1.8m
- Working power supply: DC24V
- Motor power: 90W
- Opening time: 3-7S/90°
- Closing time: 3-7S/90°
- Open time time: 0-20S
- Max. opening angle: 95°
- Protection level: Ip54
- Operating temperature: -20 ~ +55°C

产品特点

PRODUCT FEATURES

- 智能广告平开门，是一种新型的广告投放载体，主要用于小区人行通道出入口、小区内部通道、商业区人行通道、酒店车站等一切需要控制人流的场所。
- 其优点有：快速更换广告画；90W直流有刷电机，多种控制方式快速开门；开关门自带遇阻自动反弹功能；缓冲关门，防止夹伤人。
- 适用于机场、火车站、酒店会所、购物中心、企事业单位、居民小区、旅游景点、海关安检等场所。

Features

- The intelligent advertising swing door is a new type of advertising delivery vehicle, which is mainly used for residential area pedestrian passages and entrances, internal passages of the community, pedestrian passages in commercial areas, hotel stations and other places that need to control the flow of people.
- The advantages are: quick replacement of advertising drawings; 90W DC brush motor, a variety of control methods to quickly open the door; automatic rebound function in opening and closing; buffer closed to prevent pinching.
- Applicable to airports, railway stations, hotel clubs, shopping centers, enterprises, residential areas, tourist attractions, customs security and other places.

结构示意图

Accessories

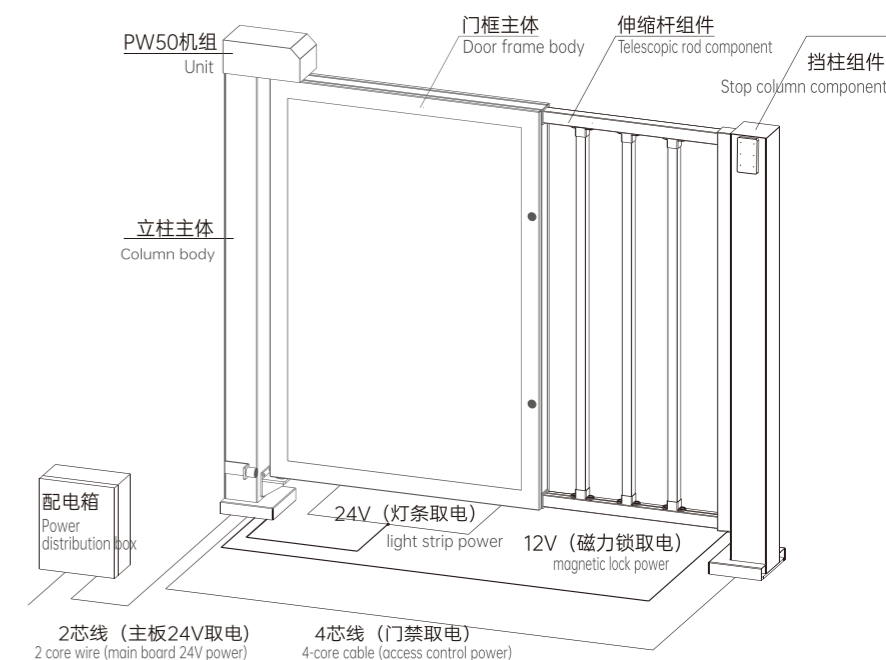

门体尺寸图

Door size chart

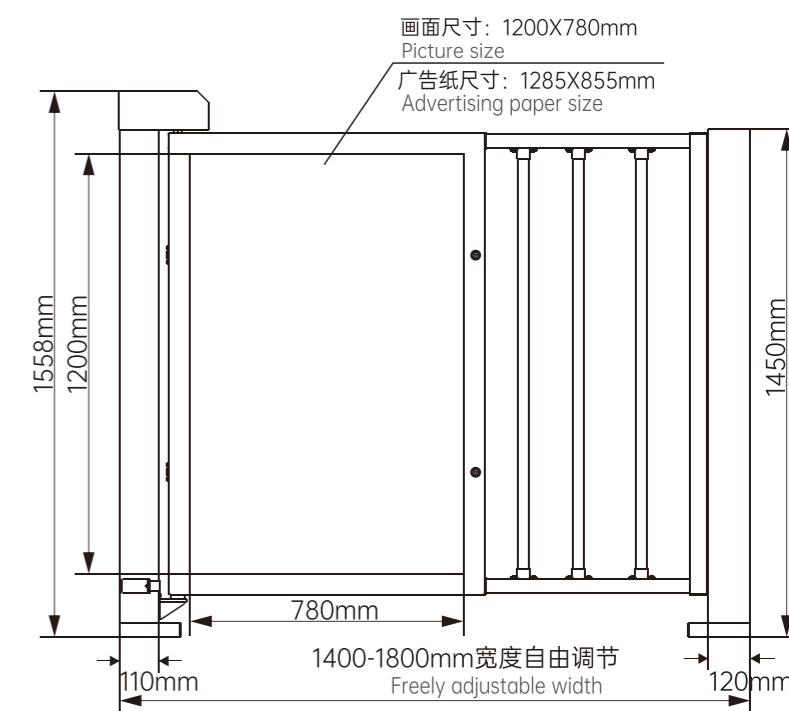

选购配件 OPTIONAL ACCESSORIES



轻触式密码读卡盘
Touch Type Access Keypad
125(L)x65(W)x17(H)mm



移动式安全光幕
Motion Top Scan
操作电压: AC/DC 12-36V
操作模式: 移动 / 静止模式



无线非接触开关
Wireless Contactless Switch
非接触感应距离: 20mm
无线距离: 视距30m、隔墙12m



无线隔空手感应开关
Wireless Spacer Induction Switch
支持: 接触感应、非接触感应
无线距离: 视距38m

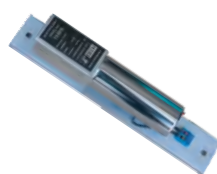

电插锁
Electric Plug Lock
203x34x40mm



遥控器
Remote Controlled Sensor
AC/DC 12-36V



无线金属轻触开关
Wireless Metal Touch Switch
安装方式: 无线贴装
无线距离: 视距38m



启动防夹红外感应器
Motion & Presence Infrared Sensor
输入电源: AC/DC 12-24V (±10%)
探测区: 1600 (W) x 800 (D) mm



专用房自动开关
Autodoor Switch For Specialroom
输入电压: AC/DC 12-36V
支持: 非接触开关、语音文字定制

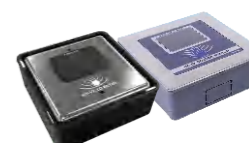

手感应开关
Hand Sensor Switch



安全光线 (单/双光束)
Safety Beam (single/double)
离地最小距离0.2米



隐藏式红外传感器
Hidden infrared sensor
100x35x37mm



无线手压开关
Wireless Handpress Switch
123x50x32mm



无线手压开关
Wireless Touch Switch



侧面防夹探头
Side Clamping Probe
78x24x30mm



UPS电源
Backup Power
DC12V, 2200mAH
DC12V, 10000mAH



无线手感应开关
Wireless Hand Sensor Switch
支持: 非接触感应
感应距离: 1-20cm可调



手感应开关
Hand Sensor Switch
支持: 非接触感应
感应距离: 1-20cm可调



无线指纹考勤三件套
Wireless Fingerprint Attendance Set
安装方式: 底板固定、无线贴装
无线功率: 视距30m、隔墙12m



无线考勤三件套
Wireless Fingerprint Attendance Set
安装方式: 底板固定、无线贴装
无线功率: 视距30m、隔墙12m



残疾人开关
Disabled Switch
操作电压: AC/DC 12-36V

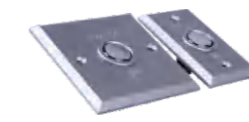

金属出门开关
Metal Exit Switch
3A/36V DC(NO/NC)输出



五档开关
Key Switch
80x80x60mm



五档程序开关
Five-range Programed Switch
AC/DC 12-36V

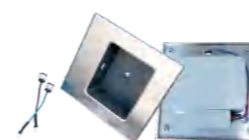

一体式脚踏感应开关
Integrated Pedal Inductive Switch
186x175x53mm



无线脚垫开关
Carpet Pad Sensor
规格大小: 1200x800
900x900 / 900x450mm

国内服务网点 Domestic service outlets

广州市欧美嘉实业投资有限公司	广东省广州市荔湾区南岸公路18号后座自编8号三层302房
广州益又和贸易有限公司	广东省广州市番禺区洛溪五洲装饰世界D137铺
广州江盛不锈钢五金	广东省广州市天河区车陂路东宏装饰城E3B档
广州市晶匠玻璃制品有限公司	广东省广州市南沙区榄核镇合沙村合砂路8号之一A101
广东振盛五金有限公司	广东省广州市南岸路广东装饰材料市场3楼3303-3304室
广州雷浦门控设备有限公司	广东省广州市黄埔区珠江村狮山路32号
佛山山海五金	广东省佛山市南海盐步大转弯夹板装饰城五期D4座(1-2)铺
新鸿东玻璃	广东省佛山市南海区洪湖路中段1号商铺
深圳鼎盛门控五金装饰	广东省深圳市宝安区广深公路新安段459号
深圳市深泰源建筑装饰材料有限公司	广东省深圳市宝安区翻身村107国道47区新安段385号
珠海市香洲雅洁恒装饰	广东省珠海市香洲区前山逸仙路272号田德花园2栋7-8号铺
东莞市德艺装饰材料有限公司	广东省东莞市东城区华兴路盛远建材城B77-B79铺
中山市石岐区广兴昌装饰	广东省中山市石岐区莲兴路2号12卡
浩源玻璃	广东省肇庆市端州区西江北路波海公园对面
通达玻璃工艺	广东省肇庆市德庆县龙母大街（港德汽修厂对面）
建夏艺术玻璃	广东省茂名市计星物流广场C4区80号
茂名华辉玻璃	广东省茂名市计星物流广场A1区010、011号铺
鸿源玻璃商行	广东省湛江市霞山区新村钢材市场内A36-37号档
建晟玻璃	广东省湛江市霞山区椴川大道五星建材城D13栋11号档
祥辉玻璃	广东省湛江市霞山区赤西三路345号
华硕玻璃	广东省湛江市赤坎区海田不锈钢玻璃市场C幅05号
宏业玻璃	广东省湛江市遂溪县遂城镇遂海路103号
恒生玻璃	广东省湛江市赤坎区海田建材批发城E幢13号
亮光玻璃	广东省湛江市赤坎区海田建材批发城E栋22号亮光玻璃
广大玻璃	广东省湛江市赤坎区海田不锈钢玻璃市场E栋11号
万基玻璃	广东省云浮市新兴县新城镇祥利花园商铺永兴街115号
雄风玻璃	广东省云浮市罗定市新公安局对面
福永五金	广东省阳江市江宁区安宁路320号之二
城兴玻璃	广东省阳江市建设路164号
玻洋玻璃工程	广东省茂名市化州市北岸北京路地税局对面
丽晶玻璃	广东省开平市人和西路7号1铺10位
彰显装饰	广东省江门市江海区江海三路（珑山居旁）
友升玻璃	广东省江门市蓬江区龙湾路龙湾工业区
江门市银盾电动闸门有限公司	广东省江门市江海区江海三路（德胜楼）
凯恩斯工程配套五金	广东省江门市新会区桥北路38-113铺
东裕玻璃	广东省鹤山市沙坪镇新城路541号之一
鸿发艺术玻璃	广东省开平市新城路8号金碧豪庭3幢105铺
佳泰门业	广东省开平市长沙幕材工业区安吉路6号首层
伟得利玻璃	广东省开平市侨园路11号1栋112-113铺
方圆玻璃	广东省恩平市新平北路45号首层
鸿轩玻璃	广东省恩平市恩城镇新城北路三十二号（即木棉侧边）
恒震益装饰	广东省肇庆市端州三路1号翠岗楼首层
粤兴玻璃	广东省肇庆市怀集县城北一路五巷36号（即金鸡桥荟创广场对面侧）
信诚玻璃	广东省肇庆市端州一路南宾日大楼铺位第十卡（即红树湾家居对面）
意境玻璃	广东省肇庆市封开县江口镇大塘一路128号（即地税局斜对面）
越兴玻璃	广东省韶关市浈江区启明路101号
梅州华锦装饰工程有限公司	广东省梅州市江南梅水路中央观邸4-7店
河源隆兴龙装饰建材有限公司	广东省河源市新市区河源大道北396号昌建大厦A101号一楼A01室
清远力创五金建材有限公司	广东省清远市人民四路美吉特华南装饰城8栋一层115-118号
大鑫钢化玻璃	广东省清远市人民四路美吉特华南装饰城A5栋126-128档

迅达玻璃	广东省清远市英德市茶园中路66号
汕头中东五金	广东省汕头市龙湖区黄河路国泰装饰材料城5街10号
松山玻璃	广东省汕头市龙湖区嵩山路89号
汕尾智家建材贸易有限公司	广东省汕尾市城区文明中路173号
威碧装饰	广东省潮州市潮州大道金田花园79-83号
连华玻璃	广东省潮州市湘桥区兴旺路6号附近
润辉玻璃	广东省潮州市湘桥区安澄公路东150米
炳记五金	广东省揭阳市榕城区东山淡浦路嘉盛家園售楼处斜对面
鹏达玻璃	广东省揭阳市揭东区城西金凤路11-13号
中兴工艺玻璃	广东省揭阳市揭东区旧坑村新区西路22附近
吉祥工艺玻璃	广东省揭阳市榕城区莲花大道西150米
鸿彬玻璃	广东省揭阳市榕城区新河路与新阳东路交叉口东北100米
华强工艺玻璃	广东省揭阳市揭东区缶灶村神树石人旁
博雅艺术玻璃	广东省揭阳市普宁市324国道南50米
贵阳先锋机电设备有限公司	贵州省贵阳市观山湖区中铁逸都C9栋401号
郑州九鑫建材有限公司	河南省郑州市郑东建材家居城D区6栋17—18号
杭州菲恩科技有限公司	浙江省杭州市萧山区义蓬镇义蓬中路722号
青岛东铁建材有限公司	山东省青岛市崂山区辽阳东路9号，高科园装饰城5号馆二楼B44-47
重庆丰铁建材有限公司	重庆市沙坪坝区大川建博中心橱柜五金城1楼15-16号
成都铭琪宏商贸有限公司	四川省成都市金牛区群星路7号交大智能小区一期南苑11栋2单元2-B
南昌汇林建材商贸有限公司	江西省南昌市巨汇.广融建材46号
中泰卫浴有限公司	江西省赣州市建材大市场六街五十七号
苏州荣道物资贸易有限公司	江苏省苏州市工业园区扬清路东明装饰城B区216
烟台米基门窗安装工程有限公司	山东省烟台市芝罘区珠玢中路18号
南宁奥西龙装饰材料经营部	广西省南宁市快环建材市场澳华花园10栋25—27号
桂林恒昊玻璃装饰材料有限公司	广西省桂林市叠彩区芦笛路31号9号楼1层门面
贺州宜居家全屋装修	广西省贺州市八步区建设东路27号
柳州市柳南区鸿云建材	广西省柳州市柳南区河西路2-6号河西建材园A10-2号
益友玻璃	广西省柳州市西环装饰建材市场
龙晶玻璃	广西省柳州市燎原建材市场F7区83-91号
贺州市八步远南玻璃装饰有限公司	广西省贺州市建设中路二机厂门面公共汽车站牌处
合肥东铁五金有限公司	安徽省合肥市蜀山区青阳路美家居五金大厅A81号
海南晨曦实业有限公司	海南省三亚市技工学校路津海建材市场三区三排10号
琼海嘉积新时代钢化玻璃	海南省琼海市善集路24号
湖北信昌工贸有限责任公司	湖北省武汉市江汉区仁厚里40号
天津东跃装饰材料有限公司	天津市南开区长江道94号创研科技产业园F1增1号
昆明丰铁建材有限公司	云南省昆明市官渡区中林建材城F区1栋11号
湖南欣颐诚商贸有限公司	湖南省长沙市芙蓉区湘湖街道三湘大市场建材城五金区2栋5号门面
长沙强威门业科技有限公司	湖南省长沙市开福区万家丽北路恒大雅苑75栋2206

海外服务网点

HENDA International Industrial Co.,(PVT)Ltd 斯里兰卡 Chau A Industry Joint Stock Company 越南河内 Bang Huu Trading Investment Import Export Co.,Ltd 越南胡志明市 TRUONG MINH Co.,Ltd 越南岷港	KAWNEER Corporation 菲律宾马尼拉
--	----------------------------

Overseas Service outlets

No 199/61, OBEYSEKERE Crescent ,RAJAGIRIYA ROAD ,RAJAGIRIYA COLOMBO Sri Lanka Plot CN4-2.1, Thach That Industrial zone, Quoc Oai Town, Hanoi city, Vietnam No 43, Str. No 2, Tan Thanh ward, Tan Phu district, Hochiminh city, Vietnam 27/27 - Nguyen Thanh Han street, Hoa Thuan Tay ward, Hai Chau District, Danang city, Vietnam 16K T.Santingo St.Brgy.Canumay West,Valonzuela City

黑科技



感谢观赏

Thank you for your time!



欧美嘉微信公众号